

enoch

Valves and Controls

Engineered Valves For Process Control

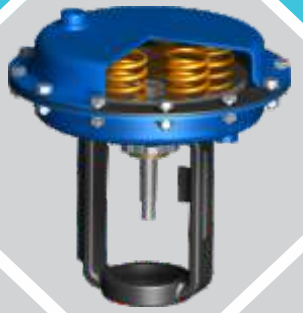

Control Valves

Choke Valves | Globe Control Valves | Angled, Jacketed and Bellow Seal Valves | Butterfly Control Valves
| Segmented V- Notch Ball Control Valve | Pneumatic Actuators - Multi & Single Spring



ABOUT US

Enoch Controls Private Limited control valve business was established to supply power Generation, petrochemical, fertilizer and downstream industries with control valves manufactured to international standards, they manufacture a range of high technology control valves, and marketing their products in India and abroad.

The quality of products supplied by Enoch Controls is assured. With full 'In-House' Engineering Design and Application Engineering capabilities, they are confident of supplying valves and actuators to Oil & Gas, Power Generation, Utilities, Off Shore, and Fertilizer Industries for all sort of applications/service. The promoters of the company have been working in Senior Management level of various reputed Multi National Valve Companies based both in India and abroad, and during the tenure of working they were seconded to various valve factories at different parts of the world, and are well aware of latest technologies and systems of valve selection, designing, and manufacturing. To ensure products Manufactured to international and export quality standards; the top management is fully involved from quoting/selection stage to dispatch and taking extra care to provide the best after sales service. With Hydrostatic, Seat leakage and performance tests in in-house and casting and other components stocked; we can ensure a fast and competitive delivery.

FACTORY

Enoch Controls Private Limited is situated at Nashik in Ambad MIDC area which is 180 kilometers from Mumbai Airport

CUSTOMERS

Enoch Controls Private Limited has been supplying valves to major process industries in the domestic and international markets. Our customer include major refineries such as ESSAR Ltd., Power Plants under various state electricity boards, and fertilizer manufacturing companies such as RCF and chemical & petrochemical units such as Thai Acrylic Fiber Co. Thailand

TRAINING

The Philosophy of the unit has been to establish a unit with the domestic expertise to manufacture control valves to International standards. To underpin Enoch Controls Private Limited designers, key personal in the unit have undergone extensive training in various aspects of control valve designs, and training is an ongoing process

QUALITY SYSTEM

Enoch Controls Private Limited is an ISO 9001:2008 company accredited by TUV. Further, we are on the process for Pressure Equipment Directive (97/23/EC), which is mandatory for exporting the products to European Community members countries.

QUALITY POLICY

Enoch Controls Private Limited is committed to design, develop, manufacturer, testing, sales and service of Control Valves and related equipments, to achieve customer satisfaction by:-

- Complying all statutory and regulatory requirements,
- Active involvement of all employees, continual improvement in all areas of Quality Management System.



Choke Valves

Choke Valves offers unique solution for various choke applications & are used for control of high pressure well fluids/solids. Our series 98000 meets the requirements of choke applications in oil production, gas injection, and sea water injection applications where pressure drops up to 400-500 bar are common. Our design incorporates various trim design from standard to Multi Stage trims which are manufactured from tungsten carbide or ceramic materials for better erosion resistance. Our choke valves designed & manufactured as per ASME B16.34 / API 6A standards, meet the requirement for Product specification levels (PSL 1, 2, 3 & 4) temperature & ratings. Our range of choke valves is available with both screwed seat design & Quick change trim (Clamped design) options. If required valves can be manufactured with NACE compliance.

Key Features/Benefits

- Robust in construction.
- High flow capacity & range ability.
- Choke valves body material can be Forged, Casted or Hipped.
- Clamped, Bolted or Screwed bonnet design.
- Various trims option from standard to Low Noise Ant cavitation trim options are available.
- Linear & Equal Percentage inherent flow characteristics.
- Heavy duty Cage Guided Construction.
- Sand erosion resistant trim.
- Metallic Scraper rings.
- High toughness carbide trims.
- Optional balanced or unbalanced plug designs.
- Easy for maintenance (Clamped design)
- Available in wide range of end connections.
- Wide range of actuator options.

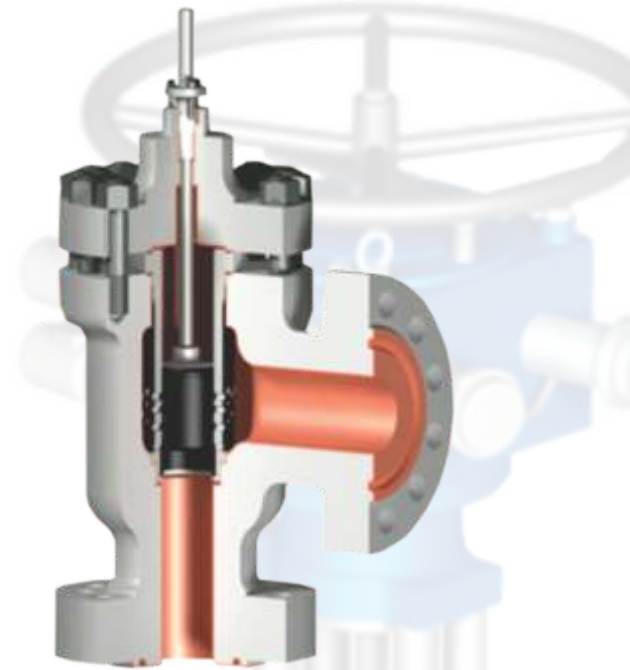

Applications:

- Chemical Injection
- Water Injection
- Gas injection & gas lift.
- Production.
- Multi-Phase flows
- High pressure drops etc

Sizes:

1" to 10" (25mm to 250mm)

End Connections:-

RF, RTJ, BWE, SWE, Hub type & others on request.

Ratings:

ASME 600# to 4500#

API 3000 to 10000

Trim Options:

Single Stage, Multi-Stage, Multi-Turn Multi Path trims.

Plug Options:

Balanced, Unbalanced.

Actuator Options:

Pneumatic Spring return diaphragm type, Hydraulic Actuators, Electric Actuators or Manual Operated with side mounted hand wheel and piston type actuators



**Standard Duty Single Seated Globe/
Angle type Control**



Series 10000/11000 &15000

Size : 1/2" to 12"
 Pressure Rating : ASME 150# to 600#
 Trim Design : Solid
 Trim Options : Skirted, Contour, Mcv & Perforated

Features:

- Precision Control
- Compact Design
- Low Weight
- Economic product due to compact design
- Easy for maintenance
- Equal % & Linear Inherent flow characteristics

Application:

- Standard Duty
- Suitable for handling low & High Pressure drop applications.
- Modulating & On/off control

Double Seated Globe Type Control Valve



Series 13000

Size : 1" to 24"
 Pressure Rating : ASME 150# to 600#
 Trim Design : Solid
 Trim Options : Contoured & MOSS (Single Stage)

Features:

- Top & Bottom Guided Valve
- High Flow Capacity
- Excellent Flow Control Rangeability
- Low Unbalance force for each valve size

Application:

- Suitable for high flow capacity
- Ideal for low & high Pressure applications

Three Way Globe Type Control Valve



Series 14000/14100/14150

Size : 1" to 12"
 Pressure Rating : ASME 150# to 600#
 Trim Design : Unbalanced or Balanced
 Metal to Metal
 Trim Options : Linear 'V' Port or MOSS

Features:

- For Proportional Mixing & Diverting Flows.
- High Flow Capacity
- High Rangeability
- Minimum Plug areas to reduce actuator force requirement.
- Linear Inherent flow characteristics

Application:

- For Mixing & Diverting Application
- In textile Industries

Single Seated Cage Guided Globe/ Angle Control Valve



Series 12000/12100/12200 /12250/12260 & 15200

Size : 1/2" to 36"
 Pressure Rating : ASME 150# to 600#
 Trim Design : Solid or Balanced
 Trim Options : Ported, MOSS, MODS, MOTS & VeloTRol

Features:

- Robust Design
- High Flow Capacity
- High Range ability
- Single, Double, Triple & Multi Stage Trims available
- Equal & Linear Inherent flow characteristics
- ASME Section VIII Body/Bonnet Bolting Design

Application:

- Oil & Gas Service
- Power & Petrochemical Industries.

**Single Seated Cage Guided Globe/
Angle Control Valve**



Series 16000/16100/16250/16350

- Size : 1" to 36"
- Pressure Rating : ASME 900# to 2500#
- Trim Design : Solid or Balanced
- Trim Options : Ported, MOSS, MODS, MOTS & VeloTRol (Velocity Control Trim)

Features:

- Compact & Robust Design
- High Flow Capacity
- High Rangeability
- Single, Double, Triple & Multi Stage Trims available
- Equal & Linear Inherent flow characteristics
- ASME Section VIII Body/Bonnet Bolting Design
- Low Noise Trim Design

Application:

- High Duty Service
- Power applications.

Velocity Control Trim (VeloTRol)

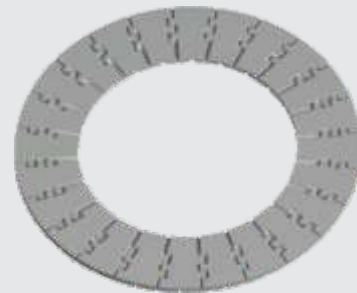
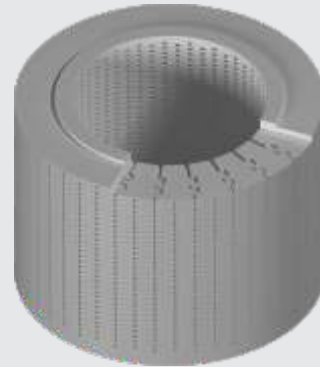

Step Vane Butterfly type control valve with/without Anti-cavitation trim

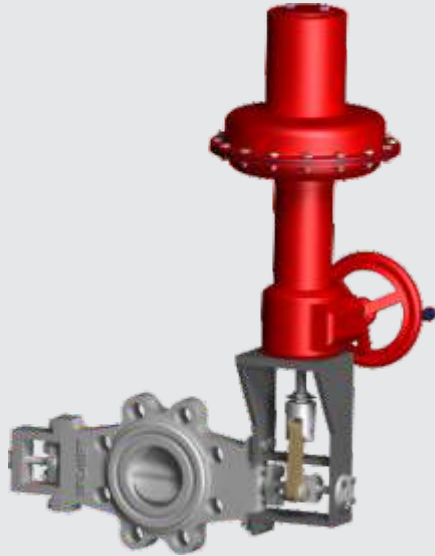

Series 40000/40500/45000/45500

Size : 2" to 56"
 Pressure Rating : ASME 150# to 2500#

Features:

- Step-Seated Disc design
- Anticavitation/Low Noise Vane Design
- High Flow coefficient
- Compact design
- Disc Design for minimum dynamic torque
- Light in weight
- Wafer/Lug Wafer & Double Flanged design
- Controls through 90 degree rotation

Application:

- Slurry applications
- Steel & Sugar industries

Swing through Vane Butterfly type control valve with/without Anti-cavitation trim

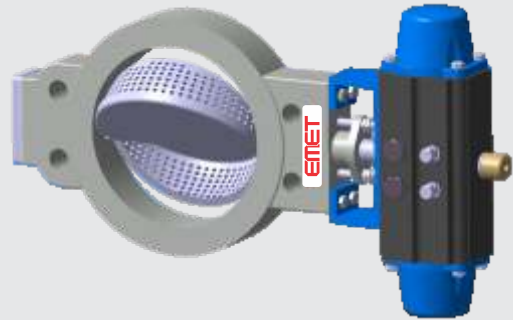

Series 40100/40600/45100/45600

Size : 2" to 56"
 Pressure Rating : ASME 150# to 2500#

Features:

- Anticavitation / Low Noise Vane Design
- Compact design
- Disc Design for minimum dynamic torque
- Light in weight
- Wafer/Lug Wafer & Double Flanged design
- Controls through 90 degree rotation
- Equal % Inherent flow characteristics
- Leakage less than 2% of Rated Cv

Application:

- Slurry applications
- Steel & Sugar industries.

Eccentric offset Metal Seated Butterfly Control Valve



Series 44000/44500/46000/46500

Size : 2" to 56"
Pressure Rating : ASME 150# to 2500#

Features:

- Eccentric Disc Design
- Compact design
- Disc Design for minimum dynamic torque
- Light in weight
- Wafer/Lug Wafer & Double Flanged design
- Controls through 90 degree rotation
- Equal % Inherent flow characteristics
- Leakage upto Class IV of Rated Cv (ANSI/FCI 70-2)

Application:

- Slurry, Paper & Pulp industries
- Chemical fertilizers industries.
- Water treatment & Gas plants

Eccentric offset PTFE Seated Butterfly Control Valve



Series 44100/44600

Size : 2" to 56"
Pressure Rating : ASME 150# to 2500#

Features:

- Eccentric Disc Design
- Uninterrupted 360 degree contact
- Excellent flow control rangeability
- PTFE seal
- Wafer/Lug Wafer & Double Flanged design
- Low Weight
- Linear Inherent flow characteristics
- Suitable for Tight Shutoff
- Low Maintenance

Application:

- Ideal for tight shutoff application
- Steel & Sugar industries.

Segmented V-Notch Ball Control Valve

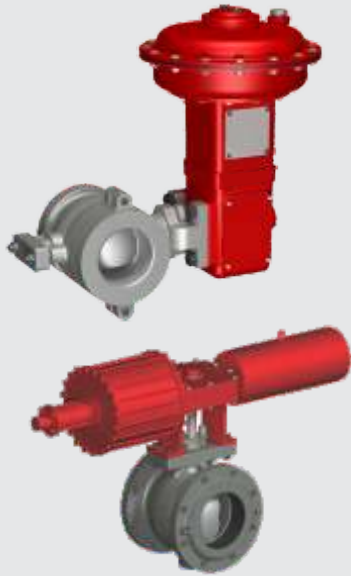

Series 50000/51000

Size : 1" to 24"
 Pressure Rating : ASME 150# to 600#

Features:

- High Flow capacity
- Precise Control Application
- V-Notch ball design used for throttling pulps & slurries
- Flangeless as well as Flanged Design
- Anti-Cavitation V-notch Ball trim available
- Excellent shear action in fibrous fluid medium
- Rangeability upto 300:1
- Smooth in operation

Application:

- Pulp & paper industries
- Fibrous & Viscous fluids
- Powder & Sugar industries

Eccentric Rotary Plug Control Valve



Series 55000

Size : 1" to 12"
 Pressure Rating : ASME 150# to 300#

Features:

- Wafer and Flanged design
- Reduced trim sizes available
- Inherent rangeability from 100:1
- Valve rotation from 60 degrees to 90 degrees
- Linear & Equal % Inherent flow characteristics
- Leakage class Upto VI
- Provides reliable & Accurate control

Application:

- For harsh & high velocity processes.
- For slurry & pulp applications.
- For clean/dirty corrosive liquid & gas service.
- In abrasive slurries.

Mechanical Desuperheater/PRDS stations



Series 60000/61000 & 70000

Type : Variable/Fixed Area Spray Unit
Pipeline Desuperheater

Size : 1" to 24" Depending upon requirement

Pressure Rating : ASME 150# to 2500#

End Connections:

- Steam Pipe : Flanged/Butt-weld
- Water Pipe : Flanged

Features:

- Design as per ASME B16.34
- High Performance spray head assembly
- Compatible with both pneumatic & electric actuators
- More turndown ratio possible
- Simple in installation.
- Large desuperheating range because of no of available nozzles

Spring Diaphragm Pneumatic Actuators

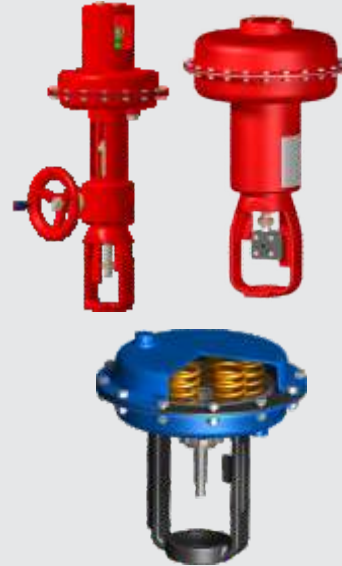

Multi-Spring / Single Spring

Actuator Type:

- Multi-Spring Actuator.
- Single Spring Actuator.

Actuator Sizes:

- For Multi-Spring Actuator, M100, M250, M350, M700 & M1400 Sq.cm
- For Single Spring Actuator, S1-500, S1-1000 & S1 2000 Sq cm.

Travel:

15 mm, 30mm, 60mm, 120mm, 200 & 300mm

Handwheel Options:

- Side Mounted Handwheel (SMH)
- Top Mounted Handwheel (TMH)

Note: SMH option available in Multi-Spring actuators also

Special Supplied Control Valves



Special Forged Globe & Angle Control Valves
Supplied To
M/s.Hindustan Organic Chemical Limited

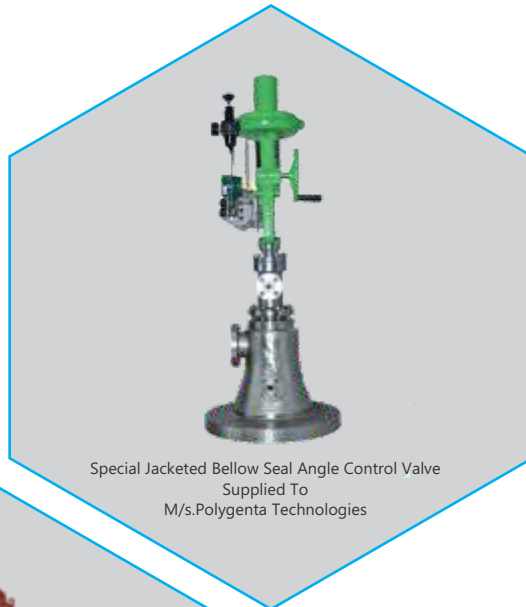

Special Jacketed Bellow Seal Angle Control Valve
Supplied To
M/s.Polygenta Technologies

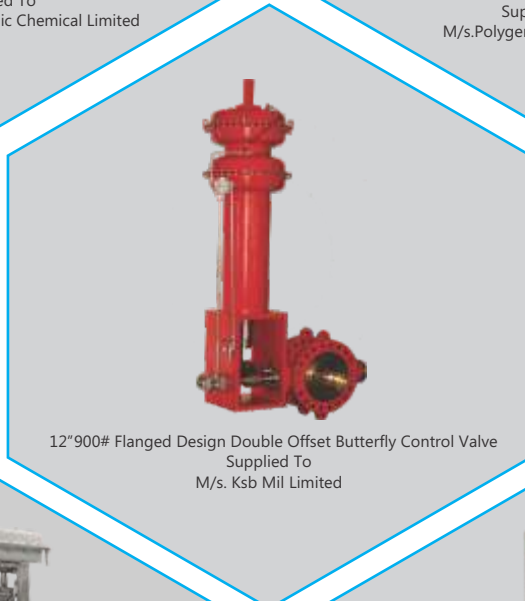

12"900# Flanged Design Double Offset Butterfly Control Valve
Supplied To
M/s. Ksb Mil Limited



1.5" 300# Bwe Vaccum Jacketed Cryogenic Control Valves
Supplied To
M/s. Institute of Indian Plasma Research

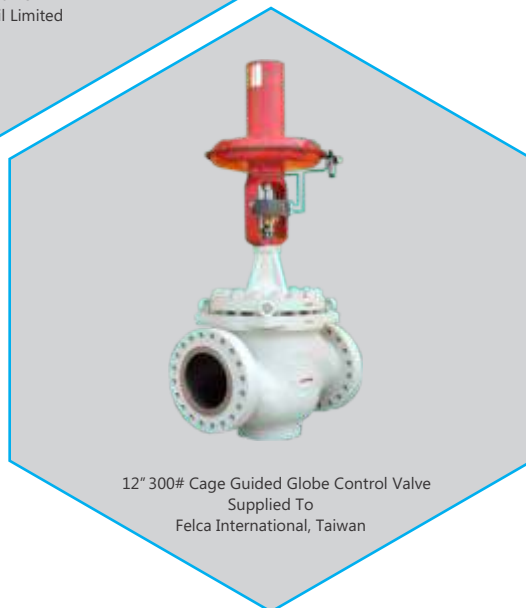

12" 300# Cage Guided Globe Control Valve
Supplied To
Felca International, Taiwan

Services & Training

Enoch Controls Private Limited is committed to meet or exceed customers' expectations by providing quality products and services. Service support is a vital aspect of our philosophy. We continue to keep our focus on rendering prompt and efficient after sales services, for all products and solutions and also offer training on products, operations and services.

We further engage in rendering Sales & Services of all items to our clients. We are backed by a team of experienced Process and Instrumentation trained professionals, who have profound expertise in this domain.



Overseas: Thai Acrylic Fibre Co. Ltd.—Thailand | Felca International Corporation —Taiwan | PT Indorama Polychem—Indonesia | Imtex Controls — U.K | Gas Transmission Company Limited (GTCL) — Bangladesh | Bangladesh Gas Fields Company Ltd. — Bangladesh | Thai Rayon Public Company Ltd — Thailand | Alexandria Fiber Co. Ltd. - Egypt | National Titanium Co. Ltd. (Crista I Global) — KSA Ace Technical Solutions — Oman| Ejad Arabia - Saudi Arabia | AVSCO FZCO - UAE Tig Tesco International Ltd. — Saudi Arabia | Provalve Armaturen GmbH & Co. KG —Germany | Lotus Controls—Spain

Domestic: UHDE IPDIL | BHEL- Bhopal | BHEL- Hyderabad | IOCL—Bongaigaon | IOCL—Digboi | DOAE | MRPLGAIL | Essar | MSPGCL | Satpura TPS | RCF | NFL | HOCL | Polygenta Technologies | Advanced Enzyme Technologies | Siemens Water Technologies | JVS Comatsco Industries | NOCIL | Alok Industries Anupam Rasayan | Gulbrandsen Chemicals | Himadri Chemicals & Industries | Rashmi Metaliks Jindal Poly Films | Nuberg Engineering | Adhunik Group | Laminar Enterprise



Manufactured By:

Enoch Controls Pvt. Ltd.

Plot No. A-40, Near Garware, MIDC, Ambad,
Nashik - 422010, Maharashtra, INDIA.

Tel. : +91 253 2383548

Fax : +91 253 2383549

Mobile : +91 9637588673

Email : sales@enochvalve.com

Web : www.enochvalve.com



enoch/



